

Style 220 and 221 Flue Gas Nozzle Couplings

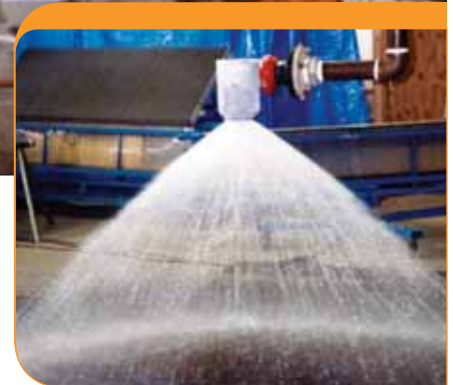

Victaulic FGD nozzle couplings are faster and easier to install than flanged nozzles, drastically reducing downtime for maintenance.

Features



Shouldered end nozzles are available from all major nozzle manufacturers.

Victaulic Style 220/Style 221 nozzle couplings provide a mechanical joint for joining shouldered alloy pipe and FRP (fiberglass reinforced pipe), respectively, for use on flue gas desulfurization vessels.



STYLE 220
FOR ALLOY PIPE



STYLE 221F
FOR FRP PIPE

- Couplings are available in 2½, 3, and 4" sizes
- Lightweight, single-bolt assembly makes installation easier and faster than traditional flanged connections. Eliminates over-tightening and possible "cracking" of nozzles.
- Allow full 360° nozzle orientation while flanged connection only permits 90° indexing of the nozzle.
- Couplings (4" size) provide 50 lb-ft plus of rotational resistance against nozzle rotational slippage.
- Style 220/Style 221 coupling housings are constructed of the same or similar materials as the pipe, providing comparable corrosion and abrasion resistance. The housings are thicker than the pipe, giving it additional strength and external corrosion and abrasion allowance when compared to the pipe.
- Victaulic Style 220/Style 221 coupling utilizes a gasket specifically designed to provide a triple seal between the pipe and the shouldered ceramic nozzle. This EPDM gasket is well suited to handle the limestone slurry pumped from the nozzle and provides a cushioning effect for the shouldered ceramic nozzle.
- Easier to replace/maintain, thereby reducing downtime due to plugging/cleaning of nozzle.



Benefits

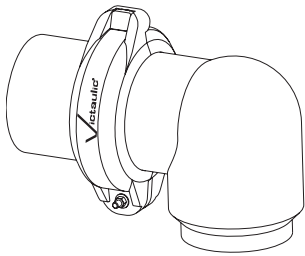

- Single-bolt assembly as opposed to four-bolt traditional flanged assembly; saves time and money
- Lighter weight/lower cost nozzle
- Uniform compression lessens the chances of breaking expensive nozzles, as opposed to point loads caused by flange bolting.
- Couplings allow for easy nozzle alignment to prevent impingement upon absorber wall.
- Lower pipe fabrication costs

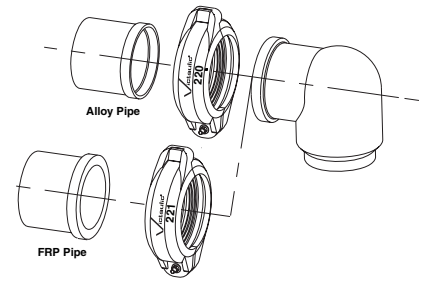

Dimensions

STYLES 221F (FRP) AND 221A (ALLOY) FGD NOZZLE COUPLING

Style	Size Inches mm	Gap	Z	YR1*	YR2*	XR*	Wgt. Ea. Lbs./Kg
221A (Alloy)	2½ 65	0.25 6.4	2.47 62.7	3.67 93.2	3.50 88.9	2.50 63.5	5.1 2.3
221A (Alloy)	4 100	0.25 6.4	2.67 67.8	4.42 112.3	4.42 112.3	3.29 84.0	7.1 3.2
221F (FRP)	4 100	0.25 6.4	3.11 79.0	4.88 124.0	4.62 117.0	3.47 88.1	3.2 1.5

* Represents radius

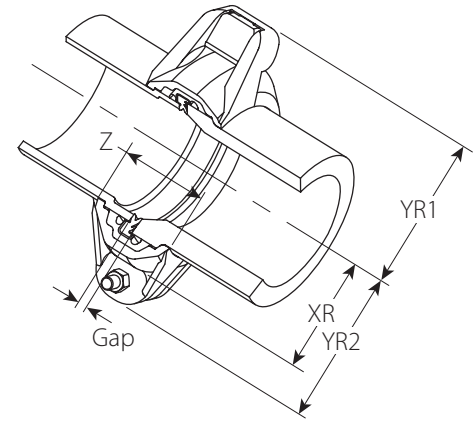

STYLE 220 TYPICAL

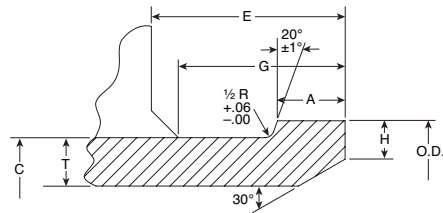

NOZZLE END FOR STYLE 220 AND STYLE 221

Size Inches mm	C Dia. Max	T Min.	O.D. ±.06	A ±0.45	E Min.	H ±.06	G Min.
2½ 65	2.81 71.4	0.63 16.0	3.75 95.2	0.78 19.8	1.67 42.4	0.63 16.0	1.52 38.6
3 80	3.81 96.8	0.63 16.0	4.25 108.0	0.81 20.6	1.70 43.2	0.63 16.0	1.54 39.1
4 100	4.81 111.2	0.63 16.0	5.25 133.4	0.88 22.4	1.76 44.7	0.625 16.0	1.60 40.6

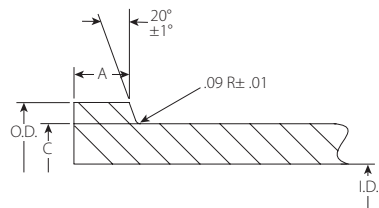

STYLE 221 FRP PIPE END

Size Inches mm	Pipe I.D.	O.D. ± .03	A +0.00 -0.03	C Dia. Max.
2½ 65	2.50 63.5	3.75 95.2	0.78 19.8	3.34 84.8
4 100	4.00 101.6	5.25 133.4	0.88 22.4	4.84 122.9

STYLE 220 ALLOY NOZZLE COUPLING

Size Inches mm	Gap	Z	YR1*	YR2*	XR*	Wgt. Ea. Lbs./Kg
3 80	0.25 6.4	2.57 65.3	3.92 99.6	3.92 99.6	2.79 70.9	5.5 2.5
4 100	0.25 6.4	2.64 67.1	4.42 112.3	4.42 112.3	3.28 83.3	6.8 3.1

* Represents radius

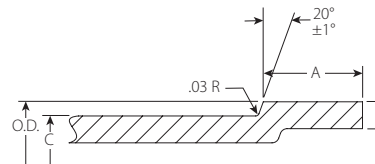

STYLE 220 ALLOY PIPE END

Size Inches mm	C Ref.	O.D. +.02 -.04	A +0.00 -0.03	T*	Victaulic Tool Required †
3 80	3.50 88.9	3.70 94.0	0.875 22.2	Sch. 10, 40, 80	VE268
4 100	4.50 114.3	4.75 120.7	0.875 22.2	Sch. 10, 40, 80	VE424/VE436

*0.120"/3.0mm for Schedule 10; 0.237"/6.0mm for Schedule 40; 0.337"/8.6mm for Schedule 80

† These tools form the above shouldered pipe end. They have special "shouldering" rolls in place of grooving rolls and are supplied by Victaulic on a loaner basis with each coupling order.

